



UPC: 019813700588

Color: White

Weight: 0.6 lbs

Project:	Type:
Prepared By:	Date:

Technical Specifications

Performance

Product Type:

A-line Contractor Series

Description:

Economical contractor grade A-lamps in convenient pack sizes that eliminate excess waste at the right price.

Wattage Equivalency:

60W Incandescent

Input Wattage:

8.5W

Lumens (Nominal):

800lm

Efficacy:

94lm/W

L70 Lifespan:

15,000-Hour LED lifespan based on IES LM-70 results

Electrical

THD:

≤20%

Power Factor:

>0.5

Dimmable:

No

Input Voltage:

120V

Operating Frequency:

60 Hz

Input Current @ 120V (mA):

166mA

Operating Temperature:

-4°F to 113°F (-20°C to 45°C)

Optical

Beam Angle:

230°

LED Characteristics

Color Temperature:

3000K

Color Accuracy (CRI):

≥80 CRI

R9 Value:

High color performance with R9 no greater than 0

Color Consistency:

<7-step MacAdam Ellipse binning to achieve consistent fixture-to-fixture color

Construction

Base Type:

E26 Edison

Finish:

White

Bulb Shape:

A19

Endcap Material:

Metal

Enclosure Material:

Plastic

Lens Finish:

Frosted

Compliance

Listings:

UL Listed

Environment:

Suitable for use in dry and damp environments

Technical Specifications (continued)

Fixture Rating:

Suitable for use in enclosed fixtures

Energy Star Approved:

This product is ENERGY STAR® Version 2.2 Certified

Model Number for Certification:

A10099(A19-8.5-E26-830-ND ECO)

T20 Compliant:

Not Compliant

California Title 24 JA8 Compliant:

Not Compliant

California Energy Commission (CEC) Status:

Not Lawful for Sales in California

RoHS:

Mercury and UV free. RoHS-compliant components.

FCC:

Complies with Part 15B of the FCC Rules

Other

Warranty:

RAB warrants that our LED products will be free from defects in materials and workmanship for a period of three (3) years from the date of delivery to the end user, including coverage of light output, color stability, driver performance and fixture finish. RAB's warranty is subject to all terms and conditions found at rablighting.com/warranty.

Note:

All values are typical (tolerance +/- 10%)

Buy American Act Compliance:

RAB values USA manufacturing! Upon request, RAB may be able to manufacture this product to be compliant with the Buy American Act (BAA). Please contact customer service to request a quote for the product to be made BAA compliant.

Case and Pallet Dimensions

	QTY	LENGTH (in)	WIDTH (in)	HEIGHT (in)
CASE	24	13.5	9.4	5
PALLET	2	42.13	39.37	40.94

Dimension

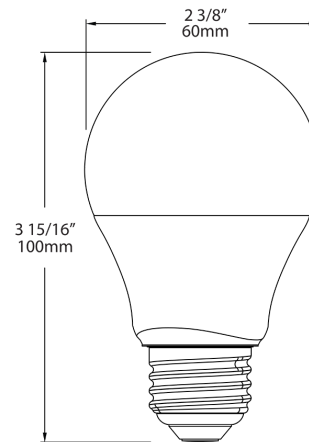

Features

- Energy efficient replacement for incandescent and halogen lamps
- Constructed from durable plastic which lowers risk of breakage
- Rated for use in open fixtures in dry or damp locations
- Frosted lens produces smooth diffuse light
- 6-pack makes it convenient for contractors

Ordering Matrix

Family	Wattage	Base Type	CRI/Color Temp	Dimmable	Pack	Voltage
A19	8.5	E26	830	ND	6PK	
	8.5 = 8.5W 10 = 10W 13.5 = 13.5W	E26 = E26 Base	850 = 80 CRI, 5000K 840 = 80 CRI, 4000K 830 = 80 CRI, 3000K	ND = Non-Dimmable DIM = Dimmable	6PK = 6 Pack	Blank = 120V